

Déterminer le diagramme des moments de flexion, des efforts tranchants ainsi que des efforts normaux des structures suivantes :

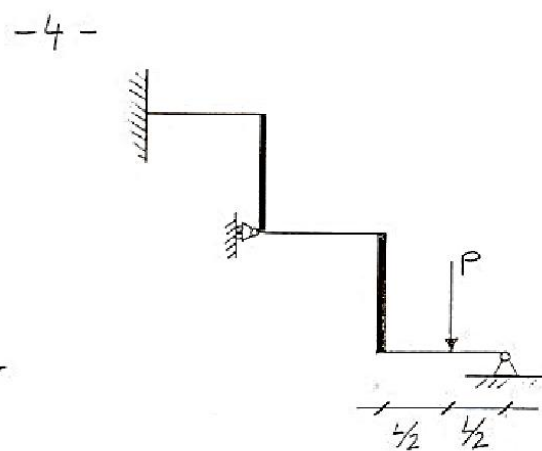

-5-

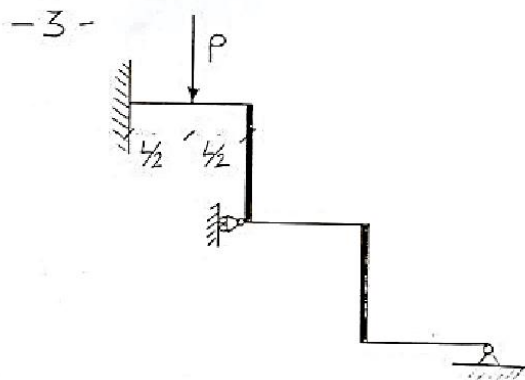
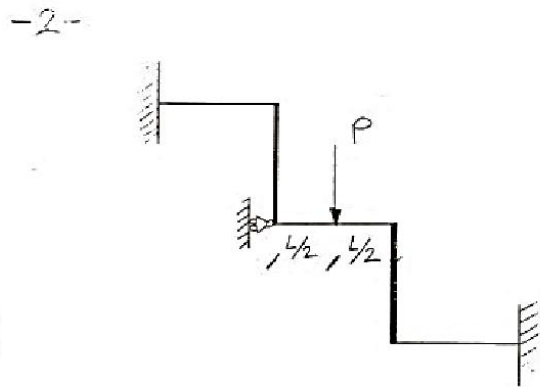
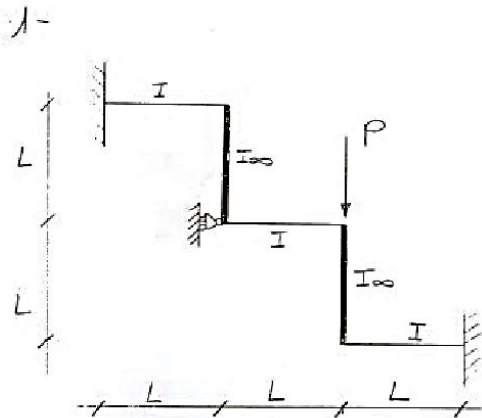
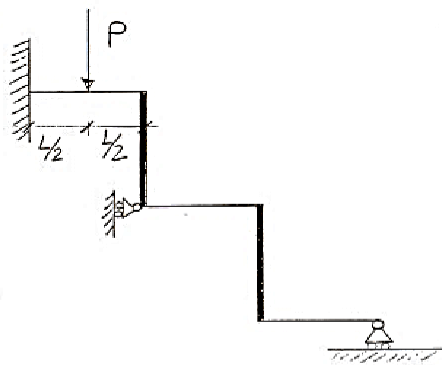

-6-

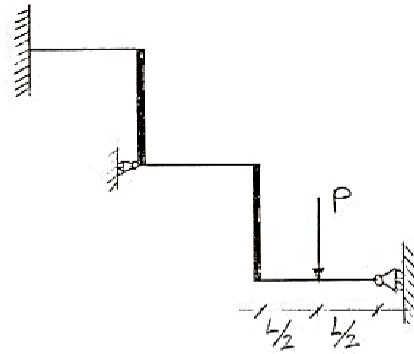

-7-

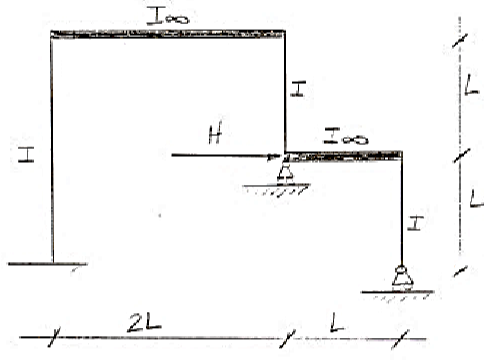

-8-

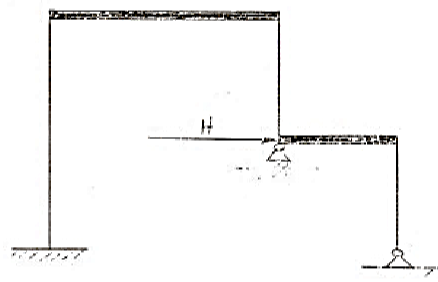

-9-

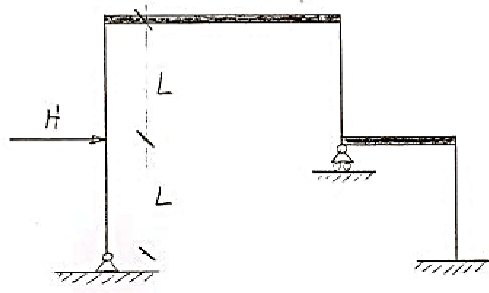

-10-

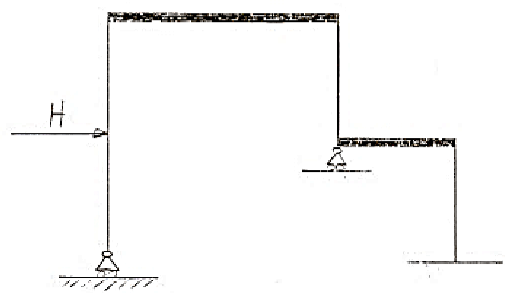

-11-

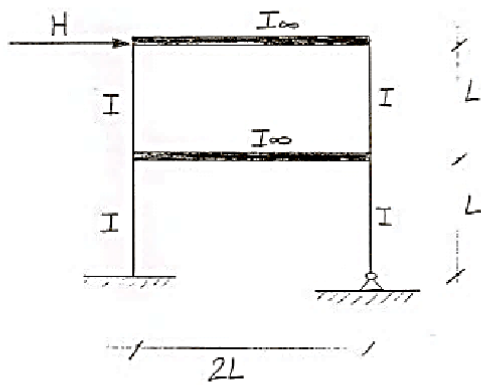

-12- -13- -14-

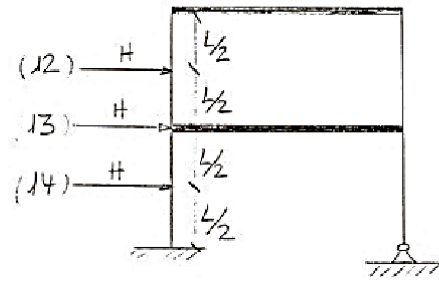

-15-

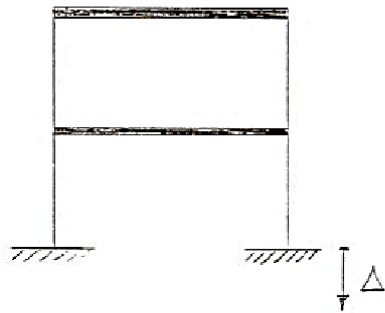

-16-

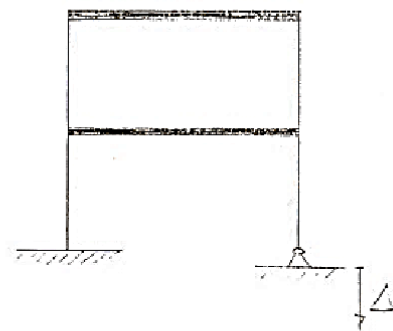

-17-

